

COBRA X PRO[®]

– auto glass repair and replacement systems



Markedets hurtigste, bedste og
mest brugervenlige løsninger



Patenteret



Patenteret



Danish design
Made in Denmark

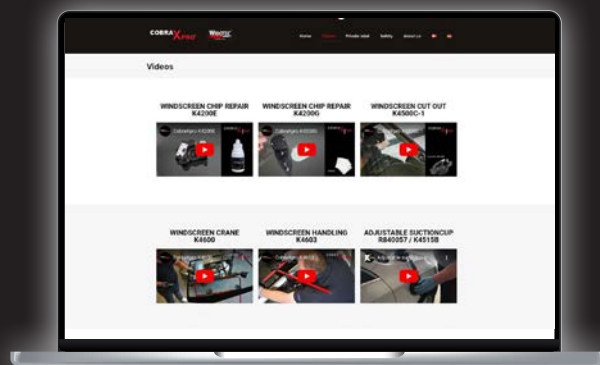

Se demonstrationsvideoer på
cobraxpro.com

Enestående patenteret teknologi, værktøj, tilbehør og forbrugsvarer

Vores program af værktøj, tilbehør og forbrugsmaterialer til professionel reparation af autoglas er udviklet og testet i samarbejde med førende specialister i autoglasbranchen.

Programmet omfatter patenteret teknologi, der positionerer os som førende leverandør af løsninger indenfor reparation og udskiftning af autoglas.

Produktprogrammet tilbydes også i private label brand til grossister i autobranche, der foruden grundig oplæring (træningsakademi) også får markedsføringsmateriale – herunder videoer stillet til rådighed.



Stenslagsreparation

Indenfor stenslagsreparation sætter vi helt nye standarder for hastighed, enkelthed og reparationskvalitet.

Stenslagsreparationer kan i forhold til andre reparationssystemer - med et minimum af oplæring - udføres på blot 5 minutter og med en succes rate på 95-98 %.

Reparationsprocessen, der hverken kræver adgang til strøm eller vakuumbudstyr, er mobil og kan derfor også udføres hos kunden.

Afhængigt af behov findes reparationssettene i forskellige udgaver. Indholdet og de nødvendige forbrugsmaterialer kan bestilles separat.

Få detaljeret information på de følgende sider...

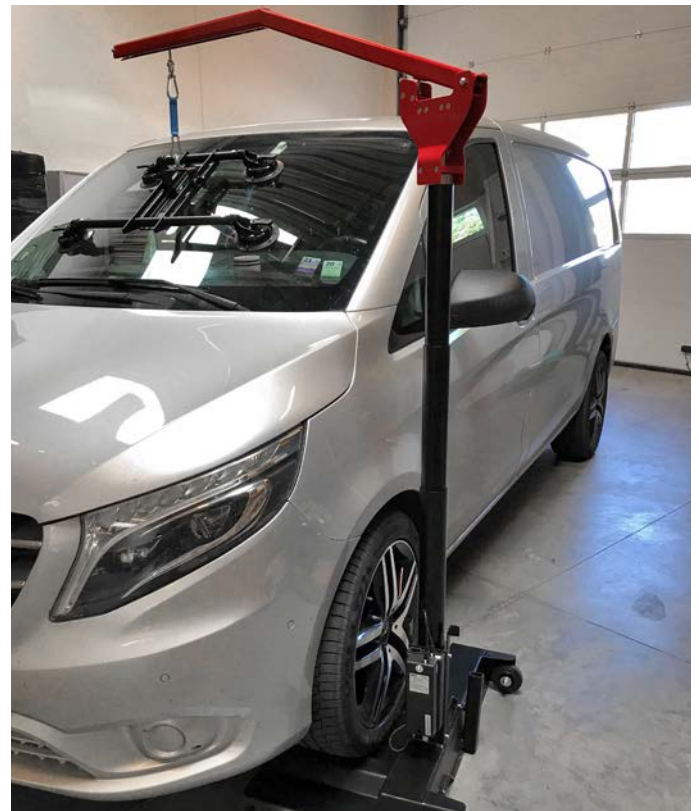

Rudeudskiftning

Med egenudviklede værktøjer sætter vi også nye standarder for hastighed, enkelthed og reparationskvalitet indenfor rudeudskiftning.

Ved anvendelse af vores udskæringsæt, kan udskæringsarbejdet - med et minimum af oplæring - ikke kun udføres langt hurtigere, men også af blot én person og med alle typer skæretråd.

Afhængigt af behov findes reparationssettene i forskellige udgaver. Indholdet og de nødvendige forbrugsmaterialer kan bestilles separat.

Få detaljeret information på de følgende sider...

Ny standard for både hastighed, enkelthed, reparationskvalitet og mobilitet

Der findes adskillige systemer til stenslagsreparation på markedet, men ingen andre performer lige så godt på de fire nok væsentligste parametre:

- Hastighed
- Enkelthed
- Reparationskvalitet
- Mobilitet

Stenslagsreparation på blot 5 minutter

Med vores 3 + 1 - proces kan en stenslagsreparation udføres på blot 5 minutter. Efter almindelig forberedelse og oprensning af stenslaget udføres følgende procestrin med vores egenudviklede og patenterede reparationsbro

1. Opvarmning til 60 ° C og nedkøling til 20 ° C på 3 min
2. Udfyldning og tryk- / vakuumproces på 60 sek.
3. Hærdning (LED UV - hærdning 30 sek. og med 95-98 % usynlighed efter hærdning)



Alle kan udføre arbejdet efter en kort introduktion

Vores system er så enkelt at arbejde med, at ALLE kan udføre arbejdet efter en kort introduktion. Der kræves altså INGEN særlige forudsætninger. Det er derfor oplagt for autoværksteder at tilbyde deres kunder denne service. Efter en kort introduktion og træning er man i gang.



Pænere reparationer med længere levetid

Vores specialudviklede resin adskiller sig på flere måder. Resinens særlige viskositet sikrer, at den flyder ud i selv de mindste revner, hvilket har betydning for hvor effektiv stenslagets revner sammenføjes og derved reparationens kvalitet og levetid. Resinen adskiller sig endvidere ved ikke at gulne over tid. Herved opnås en pænere reparation.

Men også vores pit filler adskiller sig på flere områder. Ligesom resinen gulner den ikke over tid og derudover er den kendetegnet ved en meget høj slidstyrke. Herved sikres både lang levetid og en pænere reparation.

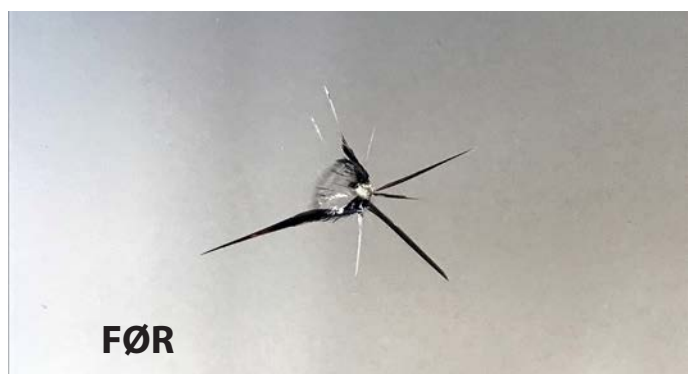

På værkstedet eller hos kunden

De fleste reparationsprocesser til stenslag inkluderer anvendelse af vakuumteknologi, hvilket ofte gør mobil anvendelse til en udfordring. Med vores egenudviklede og patenterede tryk- / vakuumteknologi kan reparationer lige såvel udføres hos kunden som på værkstedet. En stenslagsreparation kræver INGEN adgang til strøm eller lignende.

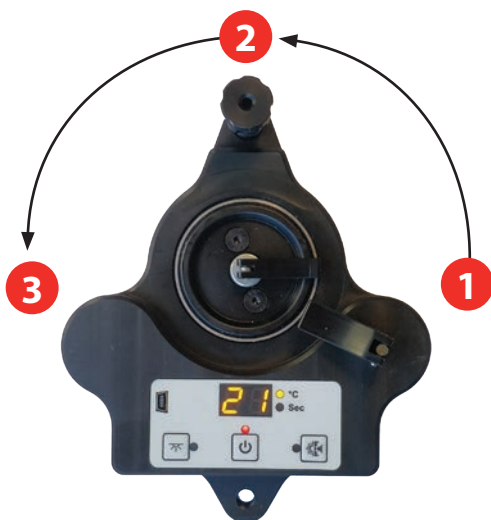

I private label og med alt hvad du behøver for at komme godt i gang

Produktprogrammet tilbydes også i private label i grossistledet. Foruden den obligatoriske oplæring og træning af grossistens personale, tilbyder også markedsføringsmateriale, så man som grossist kommer godt og hurtigt fra start, eksempelvis:

- Brochurer
- Demonstrationsvideo med egne medarbejdere
- Hjemmeside setup med kundesupportfunktion
- Stenslagsplaster med telefonnummer





K4200C

Varenummer	Navn
K4213-2	Reparationsbro 3i1
K4213	Reparationsbro
K4215A	UV-led lampe 30 sek. hærdetid
3027	Ladekabel
K4221-1	Boremaskine 3,6 V inkl. ladekabel
K4212-5	Glasbor kugleformet x 5
K4208-1	Tryk-/vakuumbempel og sprøjte
K4220	Stenslagsåbner
K4219	Revneåbner
K4230	Linerfilm/hærdefilm firkant x 5
K4210	Linerfilm/hærdefilm rulle
K4211	Barberblade x 5
K4205	Pit filler 5 ml
K4214-1	Spejl med sugekop justerbart
910008	Sprøjte og nål
K4207-1	Gel 10 ml
K4202	Resin 5 ml
K4206-1	Polish 10 ml
3012	Kuffert til K4200C og K4200H
2060	Lighter
4008	Oplader 220 V
K4202-2	Resin sæt (10 x pipette)
K4202-3	Resin sæt 1
K4202-4	Pit filler sæt 2



K4200H

Varenummer	Navn
K4213-2	Reparationsbro 3i1
K4221-1	Boremaskine 3,6 V inkl. ladekabel
K4212-5	Glasbor kugleformet x 5
K4208-1	Tryk-/vakuumpempel og sprøjte
K4220	Stenslagsåbner
K4230	Linerfilm/hærdefilm firkant x 5
K4210	Linerfilm/hærdefilm rulle
K4211	Barberblade x 5
K4205	Pit filler 5 ml
K4214-1	Spejl med sugekop justerbart
910008	Sprøjte og nål
K4207-1	Gel 10 ml
K4202	Resin 5 ml
K4206-1	Polish 10 ml
3012	Kuffert til K4200C og K4200H
2060	Lighter
4008	Oplader 220 V
K4202-2	Resin sæt (10 x pipette)
K4202-3	Resin sæt 1
K4202-4	Pit filler sæt 2

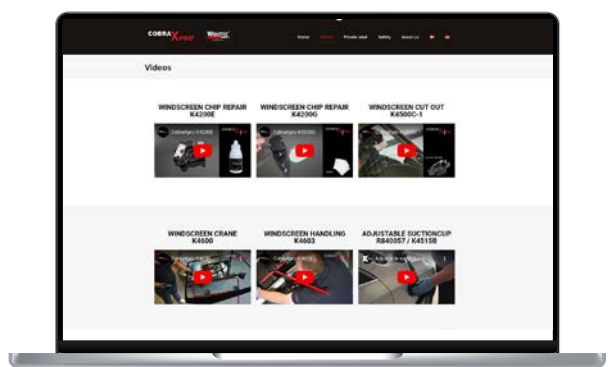

Se demonstrationsvideoer på
cobraxpro.com





K4200D

Varenummer	Navn
K4213-2	Reparationsbro 3i1
3027	Ladekabel
K4214	Spejl med sugekop
K4208-1	Tryk-/vakuumstempel og sprøjte
K4230	Linerfilm/hærdefilm firkant x 5
K4211	Barberblade x 5
K4202	Resin 5 ml
K4205	Pit filler 5 ml
K4206-1	Polish 10 ml
910008	Sprøjte og nål
3010	Kuffert til K4200D



K4200G

Varenummer	Navn
K4213-3	Reparationsbro 2i1 sort Pom.
K4221-1	Boremaskine 3,6v batteri incl. lader
K4208-1	Vacum injektor plast
K4211	Barberblade x 5
K4230	Linerfilm/hærdefilm firkant x 5
K4205	Pit filler 5 ml
4026	Rensespids
k4202-2	10 x resin pipette/ampuller
K4212-5	Glasbor kugle 5 stk
K4214-1	spejl m/sugekop flexible
K4206-1	Polish (10 ml)
4029	Box karton
4030	Skuminlæg 2i1 sæt



K4202
Resin 5 ml



K4202-3
Resin sæt 1 (K4208-1, 910008, K4202)



K4203
Resin 20 ml



K4204
Resin 50 ml



K4202-2
Resin sæt (10 x pipette)



K4202-1
Resin sæt 1 (K4208-1, K4202-2)



K4205
Pit filler 5 ml



K4202-4
Pit filler sæt 2 (K4211, K4230, K4205)



K4206
Polish 20 ml



K4206-1
Polish 10 ml



K4207
Gel 50 ml



K4207-1
Gel 10 ml



K4208-1
Tryk-/vakuumstempel og sprøjte



K4225
Pakning for K4208-1



K4209
Sprøjte og nål x 5



3015
Sprøjte



AUTOGLAS-REPARATION FORBRUGSVARER



910008
Sprøjte og nål



K4211
Barberblade x 5



910024A
Barberblade x 100



K4230
Linerfilm/hærdefilm firkant
x 5



K4210
Linerfilm/hærdefilm rulle



910009
Linerfilm/hærdefilm baner x 5



K4212-5
Glasbor kugleformet x 5



910010C
Glasbor cylindrisk



K4212
Glasbor kugleformet



K4223
Sugekop-sæt for UV-lampe og
revneåbner x 4



910028
Resin 01 3 ml



910028A
Resin 01 5 ml



910028B
Resin 01 10 ml



910003
Resin 1 3 ml



910003A
Resin 1 5 ml



910003B
Resin 1 10 ml



910002
Resin 1,6 3 ml



910002A
Resin 1,6 5 ml



910002B
Resin 1,6 10 ml



910004
Resin 2 3 ml



910004A
Resin 2 5 ml



910004B
Resin 2 10 ml



910022
Pit filler 3 ml



910022A
Pit filler 5 ml



910022B
Pit filler 10 ml



910023
Cup lub 10 ml



910013
Polish 10 ml



K4206-1
Polish 10 ml



910007
Pakning for injektor 910018



3018
Printplade til K4213-2



4004
Batteri 3,6 V til tidligere model af boremaskine



4008
Oplader 220 V



AUTOGLAS-REPARATION FORBRUGSVARER



3027
Ladekabel



3010
Kuffert til K4200D



3012
Kuffert til K4200C og K4200H



4029
Papkasse til K4200G

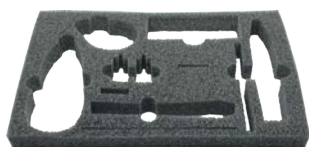

4030
Skuminlæg til K4200G

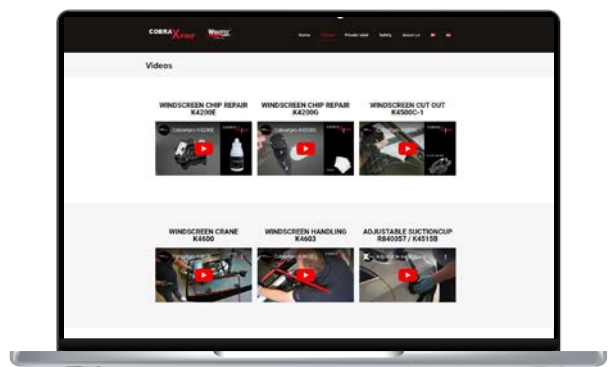

Se demonstrationsvideoer på
cobraxpro.com





K4213-2
Reparationsbro 3i1



K4213-3
Reparationsbro 2i1



K4213-1
Reparationsbro aluminium
sugekop med vipplås



910019
Reparationsbro aluminium
sugekop med vipplås



K4213
Reparationsbro



K4214
Spejl med sugekop



K4214-1
Spejl med sugekop justerbart



910016
Mityvac tryk-/vakuumpumpe



K4215A
UV-led lampe 30 sek. hærdetid



K4221-1
Boremaskine 3,6 V inkl.
ladekabel



K4219
Revneåbner



K4220
Stenslagsåbner



4026
Rensespids



2060
Lighter



k4227
Spids til stenslagsåbner

Lynhurtig rudeudskæring udført af blot én person

Der findes adskillige systemer til rudeudskæring på markedet, men vores udmærker sig i særdeleshed på følgende områder.

- Hastighed
- Ressourceforbrug
- Også velegnet til vanskelige rudetyper



Enkel og effektiv trådfastgørelse

Til alle trådtyper

Systemet kan benyttes med alle trådtyper:

- Trekanttråd
- Firkanttråd
- Fibertråd (trækstyrke 260 kg.)

Trådfastgørelse på både sugekopmodhold og modhold foregår enkelt og effektivt.



Gennemføring af tråd med trådstarter

Velegnet til vanskelige rudetyper

På mange bil- og varevognsmodeller kan pladsforholdene være en udfordring. I sådanne tilfælde kan standardværktøj ikke anvendes uden at det medfører skader på køretøjet. Vores udskærings-teknologi egner sig derimod til alle typer og ved:

- Begrænsede pladsforhold
- Varevogne



Sugokopmodhold - den 3. hånd

En ekstra hånd

Vores sugokopmodhold fungerer som en ekstra hånd. Af den grund kan rudeudskæring udføres af blot én person. Sugokopmodholdet flyttes nemt 3-5 gange ifm. med udskæringsprocessen.



Modhold med sugokop

Beskyttelse af interiør

Ved anvendelse af vores to typer beskyttere

- lige med sugelok
- instrumentbord

er det nemt at undgå at beskadige interiøret under udsæringsprocessen.

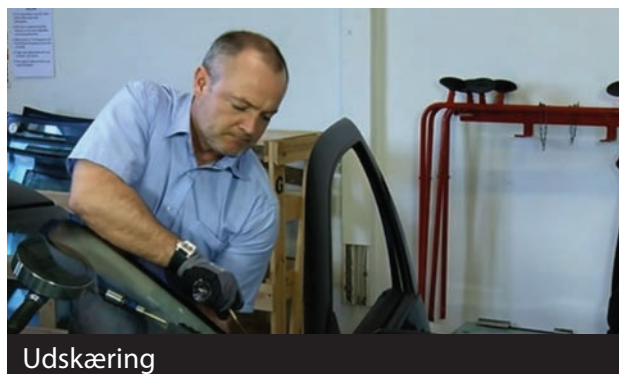

Udsæring

Alle kan efter en kort introduktion udføre arbejdet

Vores udsæringsystem er super nemt at anvende og alle kan efter en kort introduktion foretage en rudeudsæring.



Interiørbeskytter med sugelok

I private label og med alt hvad du behøver for at komme godt igang

Produktprogrammet tilbydes også i private label i grossistledet. Foruden den obligatoriske oplærning og træning af grossistens personale, tilbyder vi også markedsføringsmateriale så man som grossist kommer godt og hurtigt fra start, eksempelvis:

- Programbrochure
- Demonstrationsvideo med egne medarbejdere
- Hjemmeside setup med kundesupportfunktion

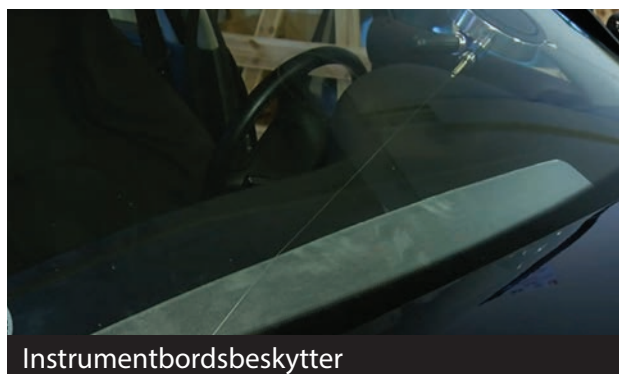

Instrumentbordsbeskytter

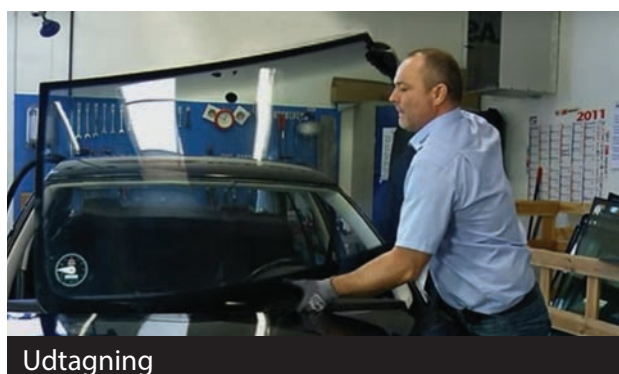

Udtagning



K4500C-1

Varenummer	Navn
K4500C-1B	Udskærer Cut-out
3014	Holder tråd for Cut-out
K4500K	Trådstarter T-håndtag med hul og slids
K4500L	Instrumnetbords beskytter med sugekop
R840049A	Plast beskytter vinkel
3022	Bitsholder
	Hobbykniv
K45HGF-5	Fibertråd trækstyrke 260 kg
R930020D	Trekanttråd 0,8mm spec. for cut out sæt
3011	Kuffert til K4500C-1



K4500

Varenummer	Navn
K4513	Selvlåsende trådhåndtag med sugekop
2086-2087	Lynkobling
K4500L	Instrumnetbords beskytter med sugekop
R840049A	Plast beskytter vinkel
K4501	Trekanttråd 25 m
2090	Kuffert til K4500
K4514	Trådstarter T-håndtag
2085	Cut-out fjeder



K4503
Firkanttråd 25 m



K4503-1
Firkanttråd 50 m



K4501
Trekanttråd 25 m



K4502
Trekanttråd 50 m



R930020D
Trekanttråd 0,8mm spec. for
cut out sæt



K4550A
Firkanttråd spec. 50 m



K4504
Guldtråd 22,5 m



R930017B
Guldtråd 3 m



R840016
Pianotråd 10 m



K45HGF-5
Fibertråd trækstyrke 260 kg



K4500H
Spider line P8 trækstyrke 165
kg



K4506
Knivblad for koldkniv 19 mm
Ultrawiz



K4507
Knivblad for koldkniv 25 mm
Ultrawiz



K4508
Knivblad for koldkniv 35 mm
Ultrawiz



K4524
L-formet kniv 19 mm for
luftudskærer



K4525
L-formet kniv 25 mm for
luftudskærer



AUTOGLAS-UDSKIFTNING FORBRUGSVARER



R950072
Knivblad lige/buet 35 mm for
luftudskærer



R950081
Knivblad lige 90 mm for
luftudskærer



R950097
Knivblad lige 57 mm for
luftudskærer



EES-804
Holder for 100 mm knivblad
Equalizer



EES-808
Holder for 200 mm knivblad
Equalizer



EES-812
Holder for 300 mm knivblad
Equalizer



ESB-1304
Knivblad 100 mm med
savtænder Equalizer



ESB-1308
Knivblad 200 mm med
savtænder Equalizer



ESB-1312
Knivblad 300 mm med
savtænder Equalizer



K4510
Blade 12 mm f. Falseskraber
x 10



K4511
Blade 16 mm f. Falseskraber
x 10



K4512
Blade 20 mm f. Falseskraber
x 10



K4510B
Blade 12 mm runde hjørner f.
Falseskraber x 10



K4511B
Blade 16 mm runde hjørner f.
Falseskraber x 10

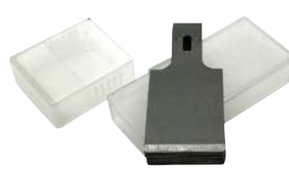

K4512B
Blade 20 mm runde hjørner f.
Falseskraber x 10



R930157
Uldkugler luksus 105 mm



R930157C
Uldkugler luksus 130 mm



K4500S
Slibesvamp rengøring af glas
f. silicone rester (10 stk)



K4500T
Slibesvamp rengøring af glas
f. silicone rester (100 stk)



K4903
Keramisk cleaner 500 ml spray



11905
Stopliste skum 5x5mm rulle
5 m



K4517B
Gummikop for rudebord



3034
Sugekop til K4500C-1B



K4500C-1B
Udskærer Cut-out



3014
Holder tråd for Cut-out



SHP-150-02
Pumpe til K4500C-1B



3062
Spole til K4500C-1B



2090
Kuffert til K4500



3011
Kuffert til K4500C-1



R840017
Trådhandtag træ



R840015
Udskærer sæt (piano tråd og træhandtag)

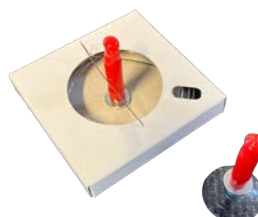

K4500J
Holder for tråd



K4513
Selvlåsende trådhandtag med sugekop



R930184
Selvlåsende trådhandtag



K4553
Modhold rund



R930116
Modhold rund and selvlåsende trådhandtag set



K4500K
Trådstarter T-handtag med hul og slids



K4514
Trådstarter T-handtag



R930129
Trådstarter nål



K4505
Koldkniv easy change Ultrawiz



R840084D
Koldkniv aluminium med Ultrawiz klinge



R950001
Luftudskærer



R930021
Falseskraber med 12 mm blad



K4509B
Falseskraber vinklet med 12, 16 og 20 mm blade



K4509
Falseskrabe sæt inkl. hobbykniv



R840048B
Instrumnetbords beskytter
metal



K4500L
Instrumnetbords beskytter
med sugekop



R840049
Plast beskytter lige med
sugekop



R840049A
Plast beskytter vinkel



R861012A
Clips aftrækker



K4554
Liste aftrækker / Volvo



R910080
Plast spartel



K4516
Lang hobbykniv HD



R930053
Glas skraber bred model



R930016B
Viskerarms aftrækker spec.
BMW



K4552
Viskerarms aftrækker 2 arme



R930016A
Viskerarms aftrækker



R930016E
Viskerarms aftrækker med
messingbøsning



R930016D
Viskerarms aftrækker 2 arme
HD



R840010
Spidstang kort



R840010A
Spidstang lang



R840018
Spidstang vinkel



R840009
Låsekiletang med 5 øjne spec.
lastbiler



R840004
Låsekiletang 9,5 mm øje



R840005
Låsekiletang 10,5 mm øje



R840006
Låsekiletang 11 mm øje



R840007
Låsekiletang 12 mm øje



R840008
Låsekiletang 15 mm øje



R840009A
Låsekiletang med 5 øjne



R840012
Kugletang lang



R840011
Kugletang kort



R840001
Snorløber 5 m



R840002
Snorløber 7 m



R840003
Snorløber 8 m



K4515B
Dobbelt sugekop ekstra læbe
med justering



K4515A
Dobbelt sugekop



K4515
Dobbelt sugekop ekstra læbe



R840054
Sugekop med vacumpumpe
Ø 230 mm



R840051
Enkelt sugekop



R840053
Sugekop med metalgreb
Pannkøke



R910056
Listepresser



3022
Bitsholder



2086-2087
Lynkobling



WSP-003-S
Spider udkærer sæt



K4500H
Spider fiber tråd P8



MS-180-WSP
Spider plast trådfører



WSP-003K-2
Spider spole



WSP-003K-BIT-L
Spider bits lang



WSP-003K-BIT-K
Spider bits kort



WSP-003K-3
Spider lejer for spole



K45HGM
Milwaukee fugepistol 12 V
310 ml patroner inkl. lader og
batteri



K45HGK-01
Milwaukee fugepistol 12 V
420 ml poser inkl. lader og
batteri



K45HGK
Milwaukee fugepistol 12 V
600 ml poser inkl. lader og
batteri



K45HG-1
Milwaukee stempel hoved til
patron sort/sort



K45HG-1A
Milwaukee stempel hoved til
poser rød/sort



K45HG-5A
Milwaukee alurør 600 ml



K45HG-6A
Milwaukee alurør 420 ml



K45HG-7
Milwaukee klarrør 600 ml



K45HG-8
Milwaukee klarrør 420 ml



K45HG-21
Milwaukees akku-bore-
maskine 12 V inkl. lader og
batteri



K45HG-4
Milwaukee lader 12 V



K45HG-3
Milwaukee batteri 12 V 2,0 AH



K45HG-22
Milwaukee batteri 12 V 4,0 AH



K45HG-9
Milwaukee multisliber 12 V



K45HG-10
Milwaukee multisliber 12 V
inkl. batteri



K45HG-11
Milwaukee multisliber 12 V
inkl. lader og batteri



Arbejd ikke hådere,
men smartere...

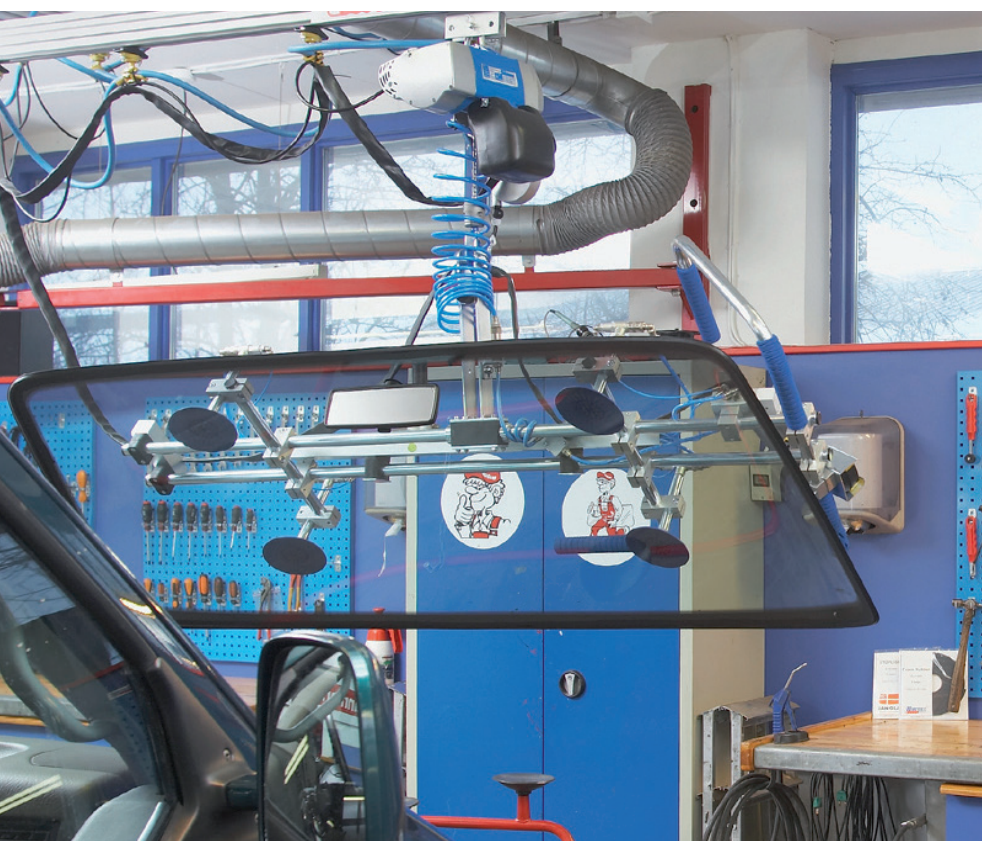

Gør rudeudskiftning:

- Muligt for én person
- Effektivt
- Ergonomisk
- Økonomisk

S10198
Forrudeløft

S10200
3m vægmonteret system

S10300
3x3m loftmonteret skinneresystem

Adskillige monteringsmuligheder gør
installationen på dit værksted enkelt

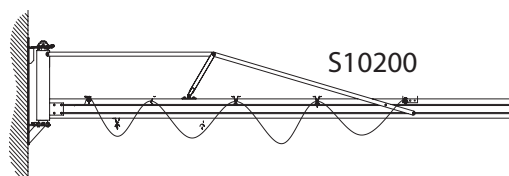

S10200

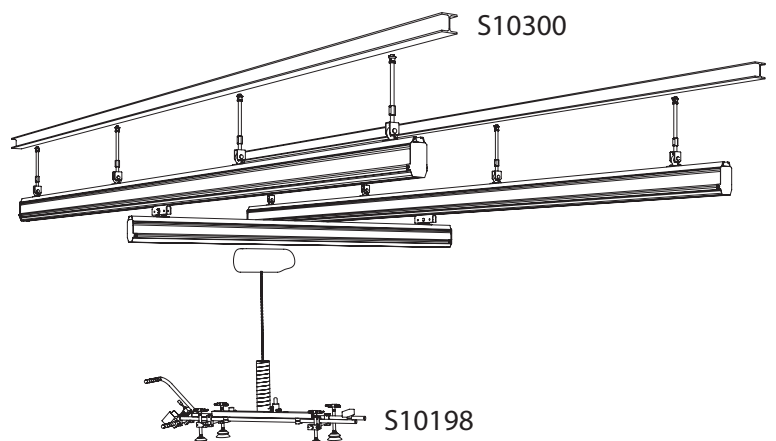

S10198



K4517
Rudebord standard



K4517A
Rudebord luksus



R840033
Rudebord med skum combi
100 cm



R840033A
Rudebord med skum combi
120 cm



R840033B
Rudebord med skum combi
130 cm



K4600-2-1
Rudebord med vippefunktion
og sugekopper med vakuum
(til trolley)



K4600-2
Rudebord med vippefunktion
og sugekopper med dobbelt-
læbe (til trolley)



K4600-2-2
Rudebord med vippefunktion
og sugekopper med vakuum (til rudebord)

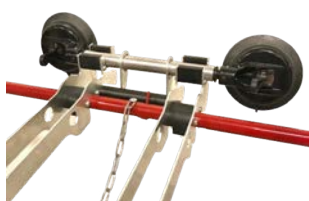

K4600-2-3
Rudebord med vippefunktion
og sugekopper med dobbelt-
læbe (til rudebord)



K4603
1-mandsmontering



K4650
Rudekran for personbil /
varevogn max 80 kg



K4600
Rudekran for personbil /
varevogn max 40 kg



K4700
Rudekran for lastbil / bus max
140 kg



R840047
Trinbræt for hjul



41JM30
Arbejdesbuk 30 cm



41JM52
Arbejdesbuk 52 cm



R870020
Rudereol enkelt 15 rum



R870010
Rudereol dobbelt 30 rum



R870040
Rudereol Van 4 rum



R870030
Rudereol væg mont. 3 rum



R840045A
Hjelmskåner (muligt med eget logo)



R840046A
Sædeovertræk dobbelt (muligt med eget logo)



R840052
Spændstrop 5 m

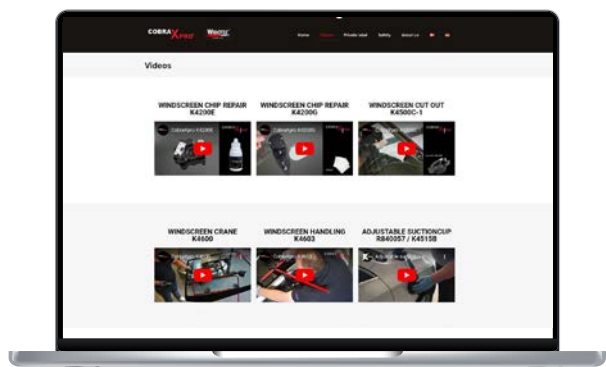

Se demonstrationsvideoer på
cobraxpro.com





FORLYGTE-POLERING/COATING SYSTEMER



K4300

Article #	Description
K4312	Polermaskine SXE400
K4315	Velcro skive
K4311	Afdækningstape
K4302	Slibe rondel K400 x 30
K4303	Slibe rondel K800 x 30
K4304	Slibe rondel K1500 x 30
K4305	Sliberondel K3000 x 10
K4314	Cleaner forlygter x 2
K4317	Polish lygtecoatning 50 ml
K4318	Poler puder Orange x 2
K4324	Lygte coatning ny klar til brug 30 ml



FORLYGTE-POLERING/COATING VÆRKTØJ



K4312
Polermaskine SXE400



K4302
Slibe rondel K400 x 30



K4303
Slibe rondel K800 x 30



K4304
Slibe rondel K1500 x 30



K4305
Sliberondel K3000 x 10



K4314
Cleaner forlygter x 2



K4324
Lygte coating ny klar til brug
30 ml



K4325
Uv spray lygtecoating



K4317
Polish lygtecoating 50 ml



K4318
Poler puder Orange x 2



K4311
Afdækningstape



K4329
Adapter til sliber



K4315
Velcro skive

COBRAX**PRO**[®]

– auto glass repair and replacement systems

Wibotec A/S

Engmarken 11, DK-8220 Brabrand

+45 87 25 11 20

info@wibotec.com

cobraxpro.com